

Standard Tubular Motor Manual V1.0.2

- Applied for motorized roller blinds, motorized awnings, motorized projection screen and garage etc;
- Composes by four parts: stator&rotor /brake /planet gearbox and limit switch ;
- Small size, low weight, weak voice, precision journey positioning, easy installation ;
- Motor have self-protection function when exact-hot, it will stop work when motor continuous working time is reaching 4-6mins and motor tube temperature is over 110°C, motor will stop running around 3-10mins, and get right working when recovered.

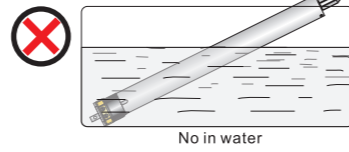

Notice

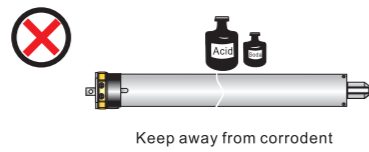
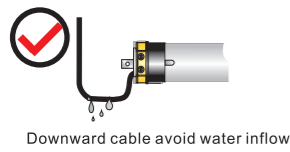
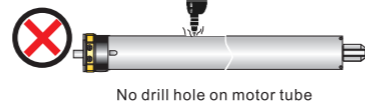
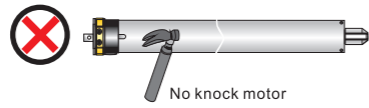
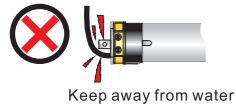

A Roller pipe preparation

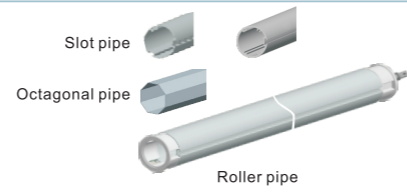
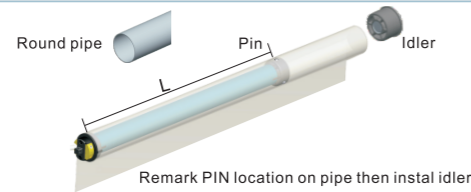
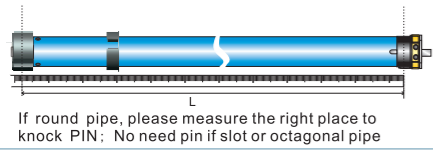

B Installation

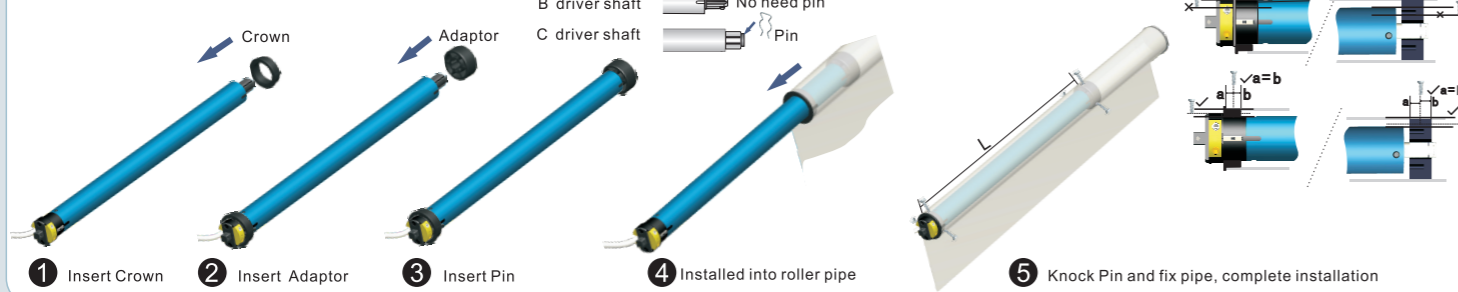

C Fix

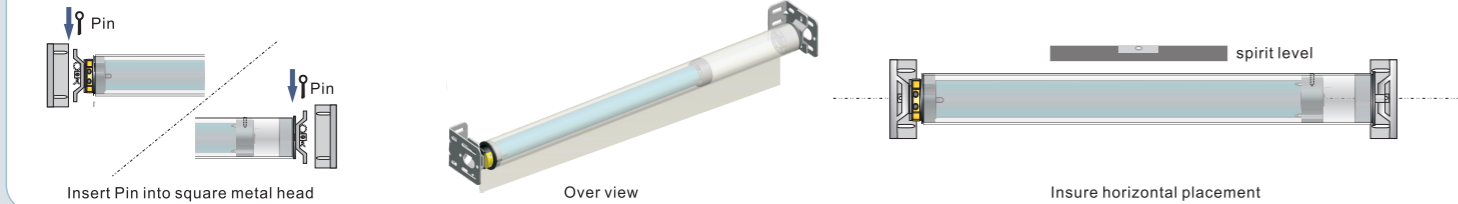

D Power wire and connection

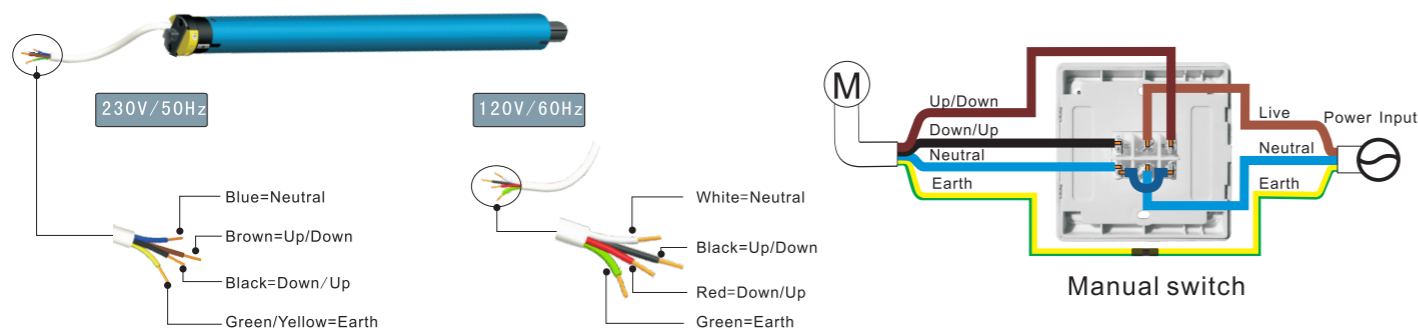

Drawing instruction

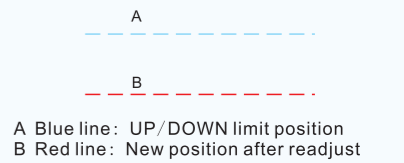
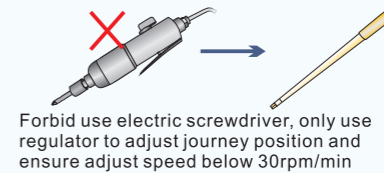
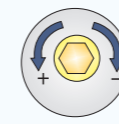
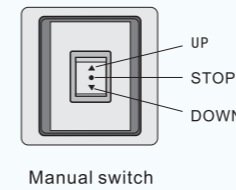

E Adjust Journey Position

Installation 1

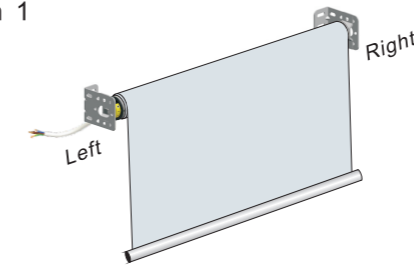

A. When motor limit head is left side, blinds outward rolling move

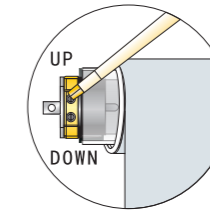

B. Adjust the UP adjusting knob to change UP limit position

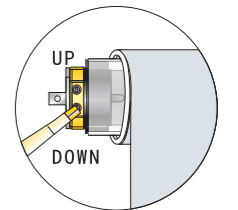

C. Adjust the DOWN adjusting knob to change DOWN limit position

Set UP limit position

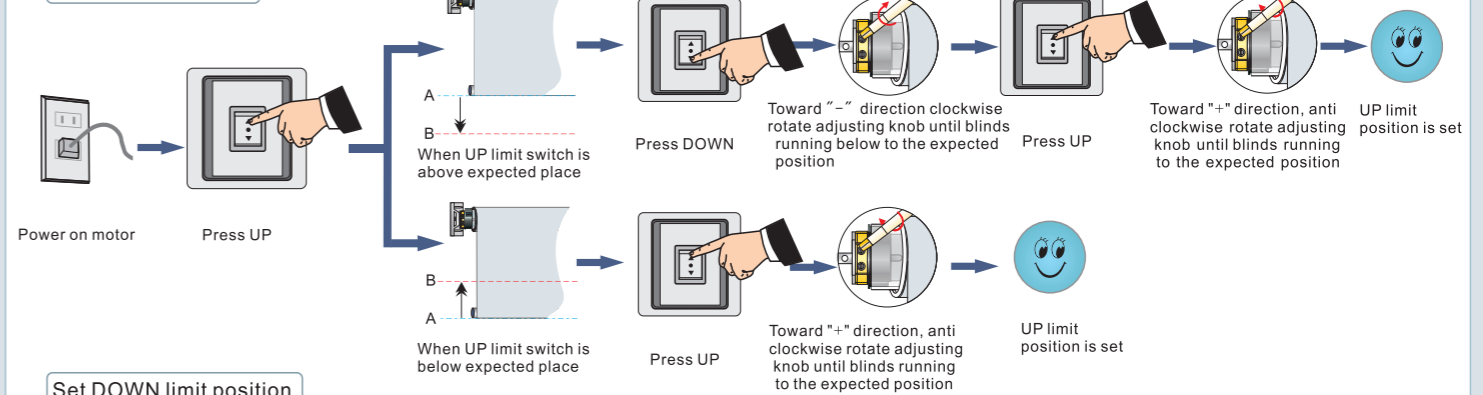

Set DOWN limit position

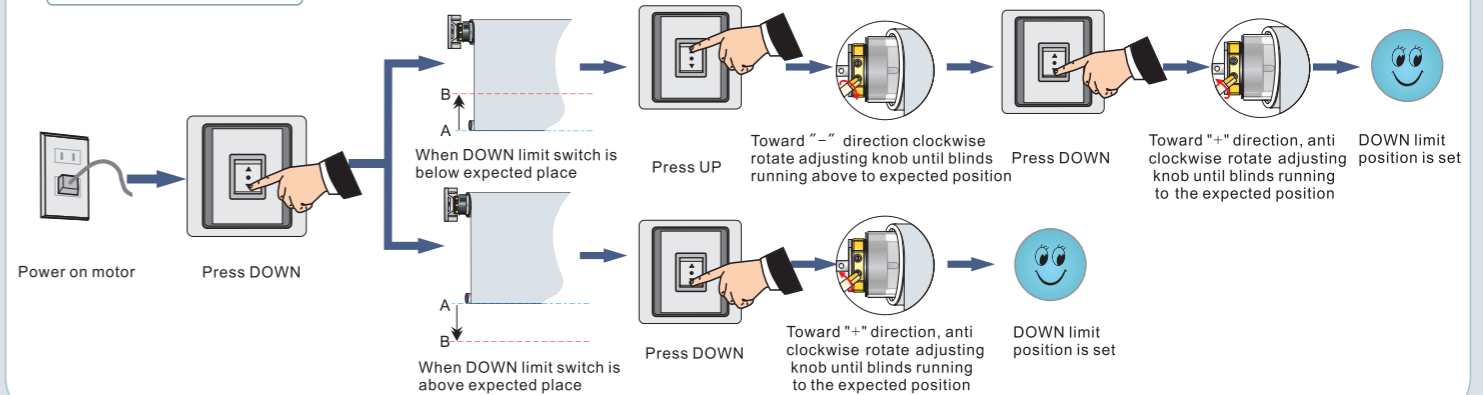

Installation 2

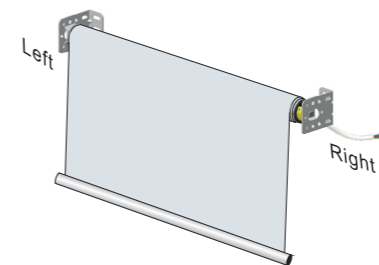

A. When motor limit head is right side, blinds outward rolling move

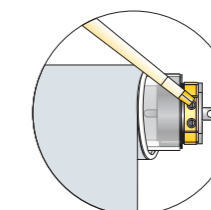

B. Adjust the UP adjusting knob to change UP limit position

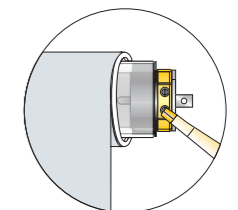

C. Adjust the DOWN adjusting knob to change DOWN limit position

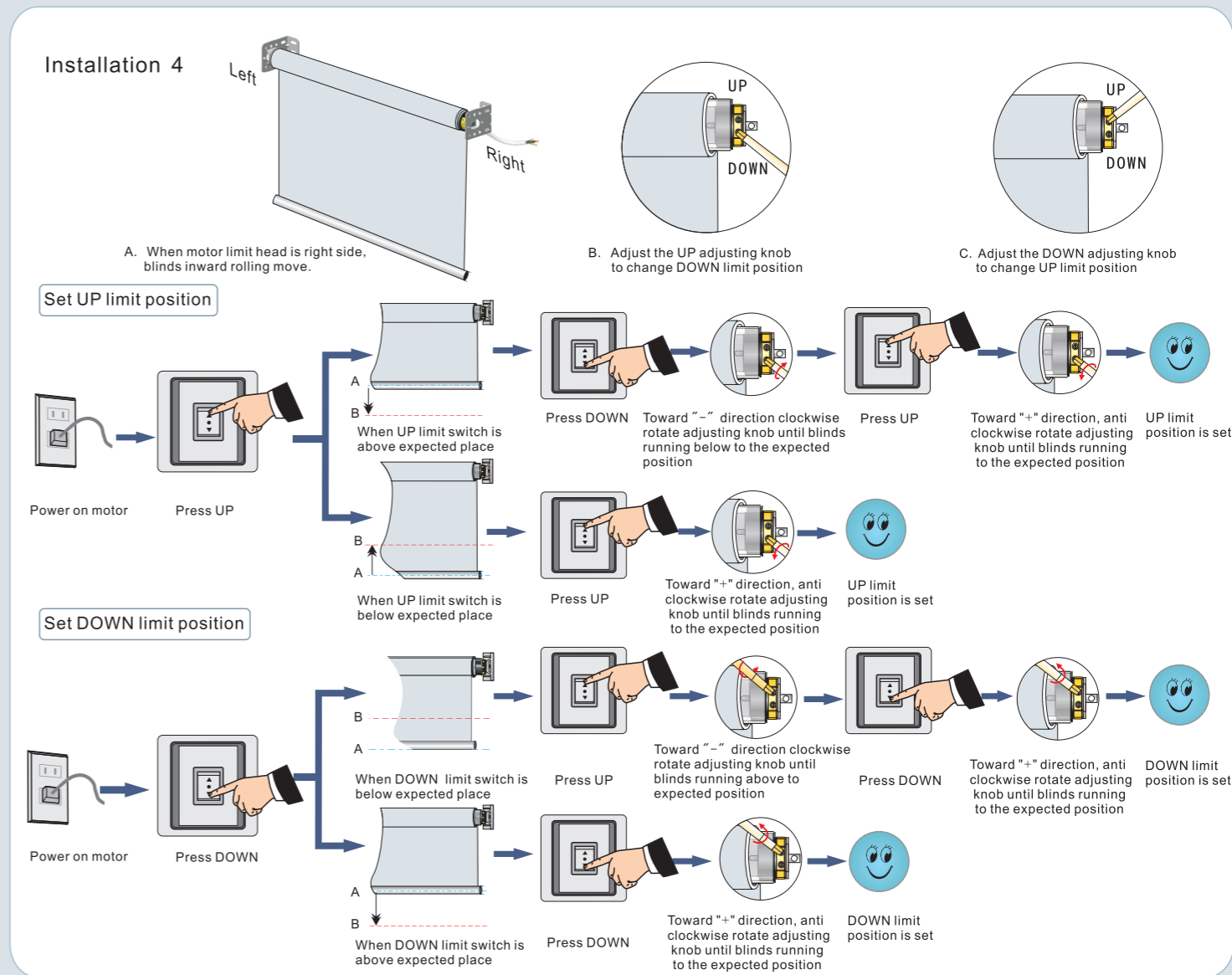
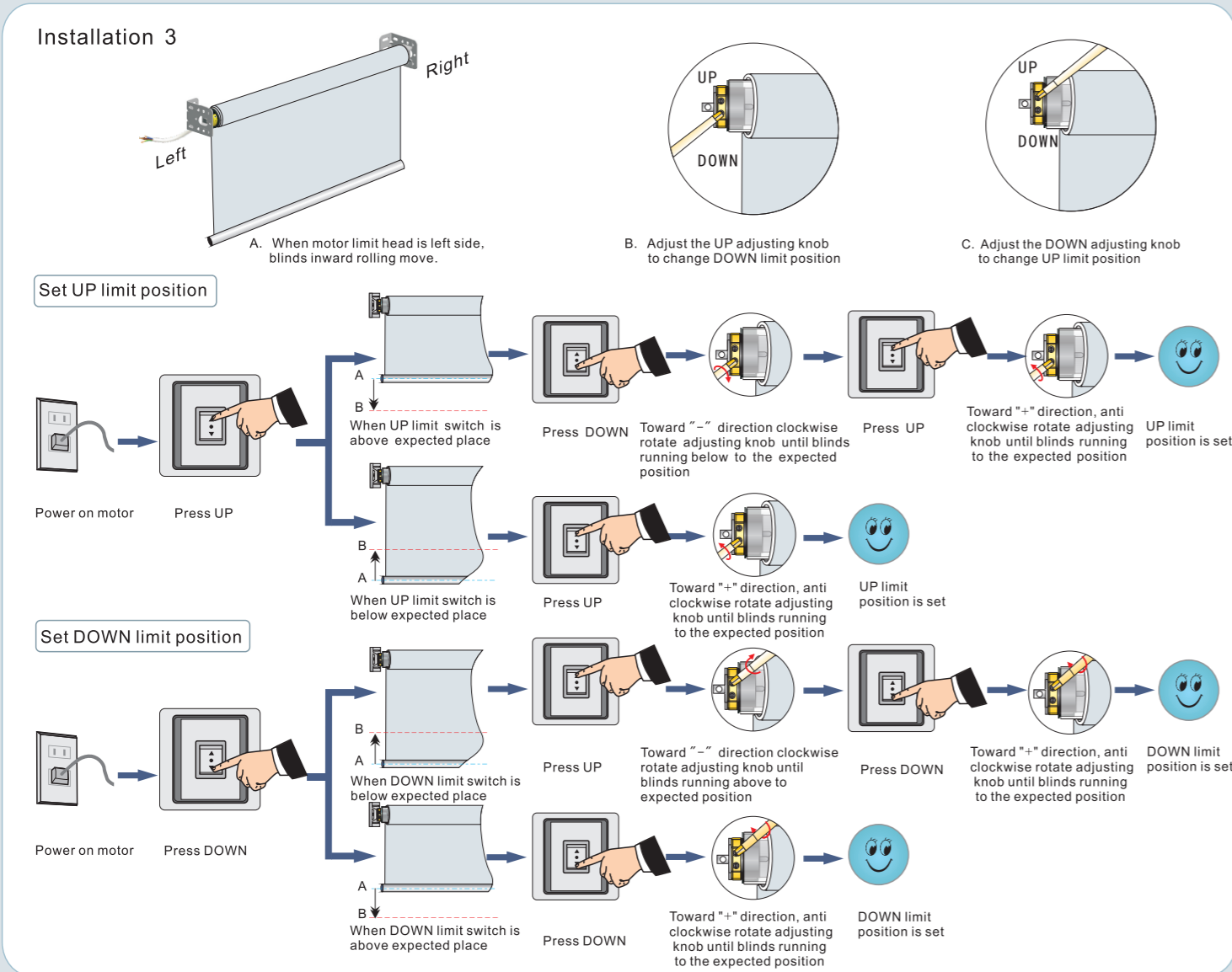
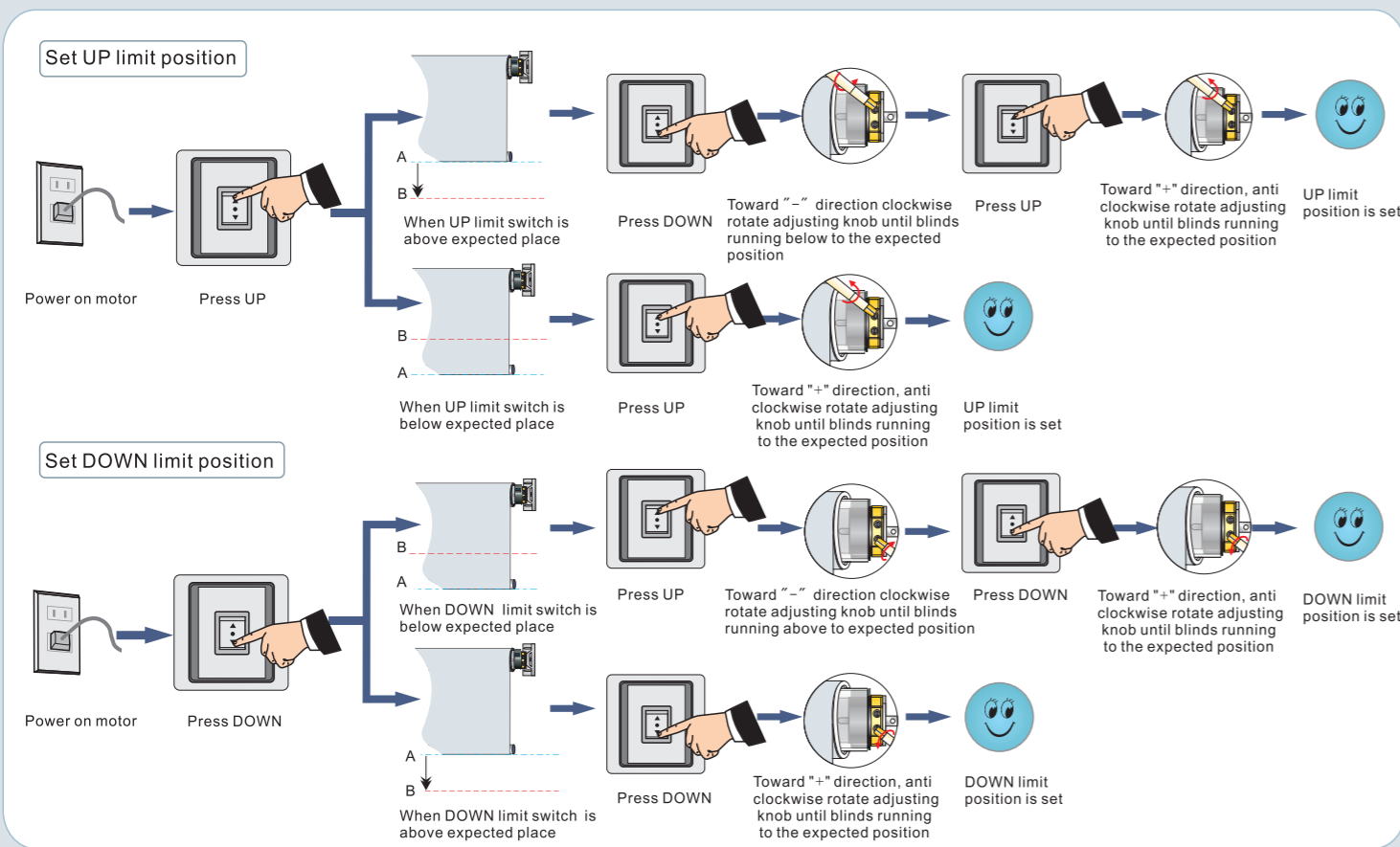

Remark: 25° angle limit motor (Picture2)

Adjust journey position by adjusting knob as Picture 1.

Set UP limit position : Corresponding above four installation, the same as set DOWN limit position

Set DOWN limit position : Corresponding above four installation, the same as set UP limit position

Picture 1

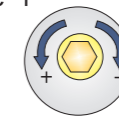

Clockwise: Increase journey
Anticlockwise: Decrease journey

Picture 2

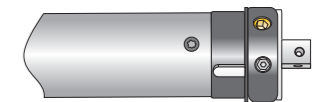

25° angle limit motor

F Troubleshooting

Items	Problem	Matter	Shooting
1	After connecting with the power, the motor can not work or work slowly.	a. The voltage is wrong b. Over loading c. Wrong installation cause accessories stuck	a. Change to rated voltage b. Adjust loading until safety loading c. Check accessories and ensure the correct installation
2	After connecting with power, only one direction can work, the other direction can not work	The limit position of fail working is not opened	Rotate crown 1or 2 circles by hand on the opposite of motor current running direction
3	The motor stops running suddenly	a. The motor is in the mode of over-heat protection; precaution, over 130°C b. Power is off c. Motor arrived at the limited position	a. when temperature drops(after about 3 minutes), the motor will come back to work again b. Once connecting with the power well, the motor will come back to work c. To check whether need to change limit position by adjusting knob
4	Press controller / switch's DOWN button, blinds UP running	Wrong wiring	Exchange the connection of black and brown/red wires